

## 9W deep anti-glare RGB+CCT downlight (Zigbee 3.0 + 2.4G)

Model No.: FUT077ZR

### Product Feature

- ZIGBEE3.0 standard protocol
- Deep plastic enclosure with best anti-glare performance, UGR≤19
- Dimmable RGB and CCT ( 2700-6500K)
- smooth dimming with 4096 level, mini brightness 0.1%
- Auto-forwarding: Automatically forward the remote control signal to another master box, making the remote control distance infinite
- Auto-synchronization: The same dynamic pattern is automatically synchronized to keep the pattern consistent
- Have DND function, usually used in power failure area and save power
- Support TUYA SMART app control (ZIGBEE3.0 gateway is needed)
- Support third party voice control like Alexa, Google assistant, Yandex Alice, Tmall Genie, Baidu and Xiaomi



### Product Parameter

Product Name::	9W deep anti-glare RGB+CCT downlight	IP rate:	IP20
Model No.:	FUT077ZR	Working Temperature:	-10~40℃
Input voltage:	AC100~240V 50/60Hz	Hole Size:	75mm
Power:	9W	Dimming Level:	4096
Power factor:	>0.5	Dimming Range:	0.1-100%
CRI:	>90	Dimming Curve:	logarithm
Color temperature:	2700~6500K	EMC Standard (EMC):	ETSI EN 301 489-1 V2.2.3 ETSI EN 301 489-3 V2.3.2
Luminous Flux:	550LM	Security Standard (LVD):	ET IEC 60598-1:2021+A11:2022 EN 60598-2-2: 2012 EN IEC 62031:2020+A11:2021 EN 62498:2015+A1:2022
Luminous efficiency:	60LM/W	Radio equipment (RED):	ETSI EN 300 440 V2.2.1
Beam Angle:	24°	Certification	CE, EMC, LVD, RED
Protocol:	2.4GHz RF		
Control Distance:	30M		

### Dimension

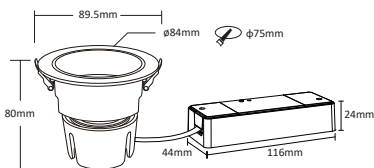

## Installation Tips

Please read instruction before installing it, you can contact with our service center if there is any technical issue

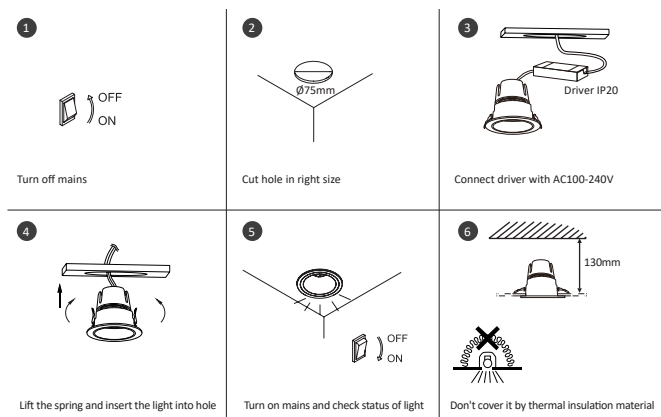

Lighting source can not be replaced, please buy new light if the light is over lifetime

## Auto-forwarding & Auto-synchronization

### Remote control signal auto-forwarding

The remote control signal received by the host will be forwarded to another host within 30m, making the control distance infinite.

### Dynamic mode auto-synchronization

In the same dynamic mode, the lamps will be automatically synchronized so that the dynamic effects are always consistent.



# Link/Unlink

**Link** controller must link with remote before using it

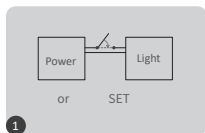

turn off light 10 seconds and turn on again



short press " | " 3 times within 3 seconds

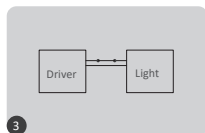

link is done once light flashes 3 times slowly



Link is failed if light doesn't flash, please repeat above steps (Attention: can not link again if remote already finished linking)

## Unlink:

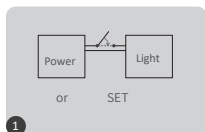

turn off light 10 seconds and turn on again



short press " | " 5 times within 3 seconds

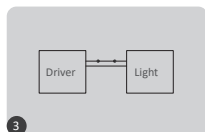

link is done once light flashes 10 times quickly



Unlink is failed if light doesn't flash, please repeat above steps (Attention: no need to unlink if the light never be linked)

## Compatible Remote ( purchase separately)



BB



B0



B3 / B3-B / T3



B4 / B4-B / T4



S2-B / S2-W  
S2-G



S2W+



S1W+



FUT100



FUT089  
FUT089-B



C5



FUT092  
FUT092-B



FUT088



FUT096  
FUT096-B



WL-Box1



FUTD01

## Dynamic mode table selection

**Select dynamic mode table 1:** While the light is in static mode, short press “S+” button 5 times quickly until blue light flashes 3 times slowly.

**Select dynamic mode table 2:** While the light is in static mode, short press “S-” button 5 times quickly until yellow light flashes 3 times slowly.

### Dynamic mode table 1 (default)

Number	Dynamic Mode	Brightness / Saturation / Speed
1	Mardi Gras	Adjustable
2	Automatic color change	
3	Sam	
4	Gemstone	
5	Twilight	
6	American	
7	Fat Tuesday	
8	Party	
9	Slow Color Splash	

### Dynamic mode table 2 (need to switch manually)

Number	Dynamic Mode	Brightness / Saturation / Speed
1	Colors gradual change	Adjustable
2	White light Gradual change	
3	RGB gradual change	
4	Seven colors jump to change	
5	Jump to change randomly	
6	Red light gradual change +Flash 3 times	
7	Green light gradual change +Flash 3 times	
8	Blue light gradual change +Flash 3 times	
9	White light gradual change +Flash 3 times	

## DMX512 LED Transmitter Control (Purchased separately)

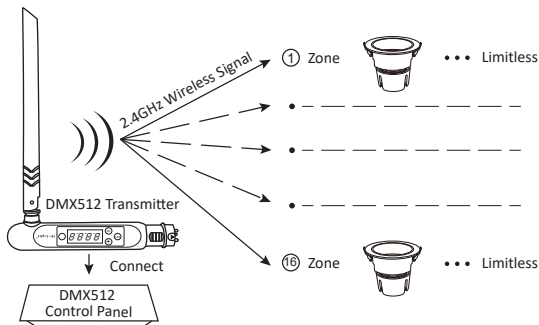

## DMX512 LED Transmitter Link/Unlink

- 1 Follow instruction of DMX512 transmitter (FUTD01), Choose the zone for the light by pressing "+" or "-" (e.g. "CH12" means zone 12)

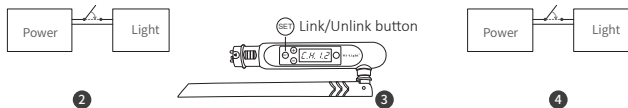

### Link

The controller is powered off for 10 seconds and then powered on, or press "SET" button 1 time.

Short press "SET" 3 times within 3 seconds while the indicator of controller is ON

Link is done once indicator of controller flashes 3 times slowly

### Unlink

The controller is powered off for 10 seconds and then powered on, or press "SET" button 1 time.

Short press "SET" 5 times within 3 seconds while the indicator of controller is ON

Unlink is done once indicator of controller flashes 10 times quickly



If the link or unlink failed, please follow the above steps again.

# DND mode ON/OFF ( factory default is ON)

## Turn ON DND:

Short press "OFF" 3 times within 3 seconds and short press "ON" 3 times, DND mode is activated if the light flashes 4 times quickly

**Attention:** The status of light ( ON or OFF) is same as turn on or off mains

## Turn off DND

Short press "ON" 3 times within 3 seconds and short press "OFF" 3 times, DND mode is shut down if the light flashes 4 times slowly

**Attention:** The light is always ON if turn on or off mains

## APP Instruction

It must connect with Zigbee 3.0 gateway and add gateway into "TUYA SMART"APP (please check gateway instruction)

- 1.Connect with mains
- 2.Enter into network pairing mode ( **factory default is network pairing mode**)  
Solution: Turn ON and Turn OFF light 3 or over 3 times continuously, the light status is breathing
- 3.Go to "TUYA SMART" APP main page and click gateway, click" Add subdevice"
- 4.Click " indicator is flashing quickly"
- 5.Dimming or group control... etc after adding successfully

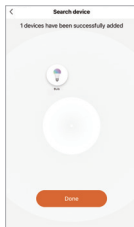
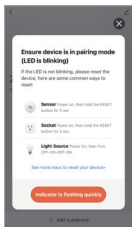
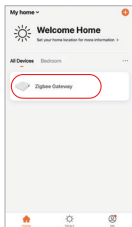

## Turn ON or OFF DND ( factory default is ON)

Click the light or the group - click " more" -Click "Power-on behavior"

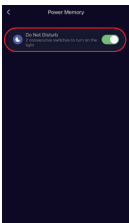
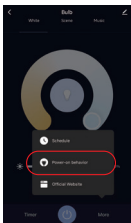
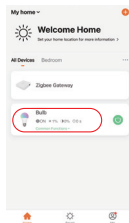

# Philips Hue Instruction

It must connect with Philips Hue and add device into "Philips Hue" APP

1.Connect with mains

2.Enter into network pairing mode ( **factory default is pairing mode**)

Solution: turn off and turn on light 3 or over 3 times continuously, the light is breathing

3.Enter into "Philips Hue"APP main page and click "SETTINGS", click "Lights"

4.Click "+"

5.Click " Search"

6.Searching device for a while and click "Start configuration", finish the steps

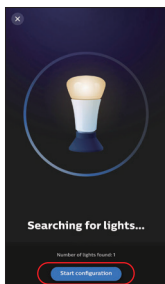
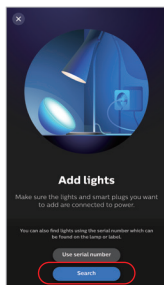
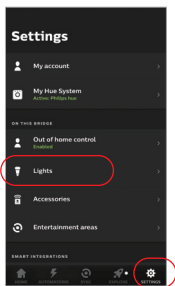

# Alexa voice control instruction

1. Alexa control (Audio conform to zigbee 3.0 protocol)

Amazon Echo can connect with device directly, the following model already conformed to zigbee 3.0 protocol)

Amazon ECHO Plus ( 2nd Gen), ECHO (4th Gen), ECHO Studio, ECHO Show (2. Gen)

1). Connect with mains

2. Enter into network pairing mode ( factory default is pairing mode)

Solution: turn off and turn on light 3 or over 3 times continuously, the light is breathing

3. Speak to Amazon Echo " Alexa, Discover devices",

search device for a while and control via your voice command directly

"Alexa, Discover devices"



2). Alexa control ( audio is not built in zigbee 3.0 protocol)

Please add device into Miboxer zigbee 3.0 gateway firstly

1). Enter into Alexa APP

2). Click "More"

3). Click "Skills& Games"

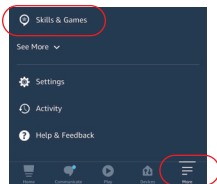

4). Click " Q "

5). Type into "smart life" and search



6). Click "smart life" skills and finish the steps

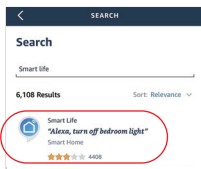

# Google Home voice control

Please add device into Miboxer zigbee 3.0 gateway

1). Enter into Google Home APP

2). Click "+"

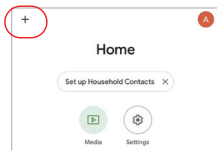

3). Click "Set up device"

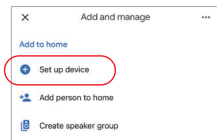

4). Click "works with Google"

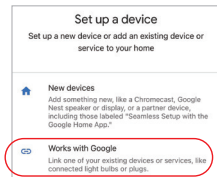

5). Click " 🔍 "

6). Type into "Smart life" and search

7). Click "smart life" skills and finish the steps

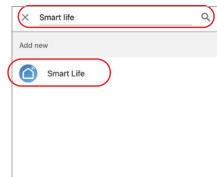

## Connection Diagram

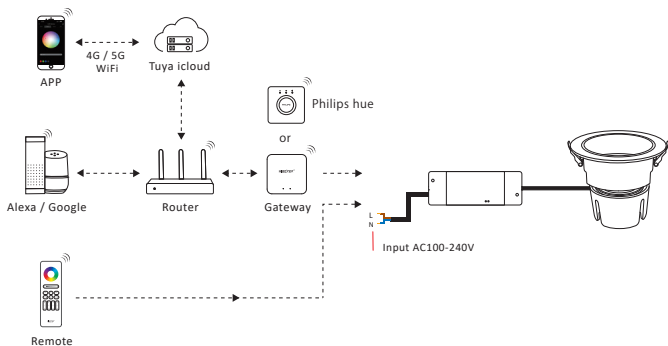

## Attention

1. Please ensure that voltage, N and L are correct connection, it will damage the light with wrong wiring
2. Please turn off mains before wiring cable and ensure that connection don't have any problem like short circuit
3. Don't disassemble it if you are not expert
4. Don't use it near magnetic or metal area, it will affect signal and reduce distance.



Made in China